

Wire Mesh pet barrier

MIDWEST Homes For Pets
P.O. Box 1031
Muncie, Indiana 47308
800-428-8560
www.midwesthomes4pets.com

Assembly Instructions for Model 13

IMPORTANT INFORMATION!

1. If you discover any parts are missing, immediately call our toll-free service helpline at 1-800-428-8560.
2. Please save sales receipt as proof of purchase for warranty purposes.

Parts Identification

Note: Illustrations not shown to scale

- (A) 2 - Main Barrier Sections
- (B) 2 - Small Extension Panels
- (C) 2 - Large Extension Panels
- (D) 2 - Rubber Tube Molding (installed at factory)
- (E) 2 - Threaded Rods (inserted in tube at factory)
- (F) 2 - Large Wing Nuts
- (G) 2 - Large Lock Washers
- (H) 12 - Plastic Clamp Plates
- (I) 6 - Bolts & Small Wing Nuts
- (J) 2 - Large Vinyl Tips
- (K) 2 - Small Vinyl End Caps
- (L) 2 - Short Rubber Tube Sound Dampeners

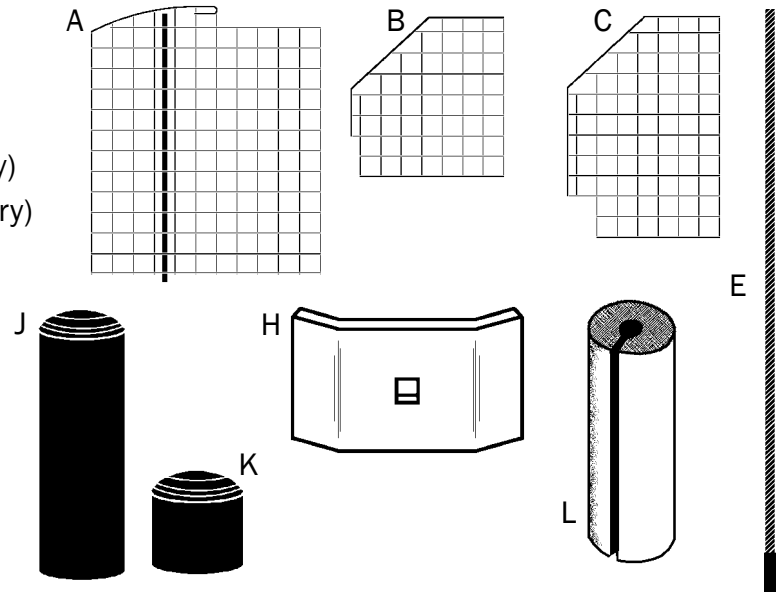

Assembly Instructions

Note: Illustrations not shown to scale

Step 1

Measure the width of the interior of your vehicle to determine how wide the Main Barrier Section should be.

Step 2

Remove the Threaded Rods (E) from the tubes on the Main Barrier Sections and set them aside. Identify the left and right main panels by placing the panels on the ground with the tubes down. Attach the Short Rubber Tube Sound Dampeners (L) to the Left panel, were shown, to eliminate any possible vibration rattles.

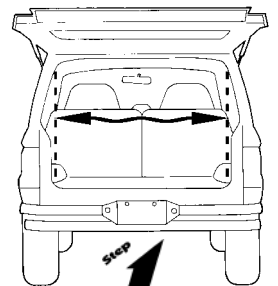
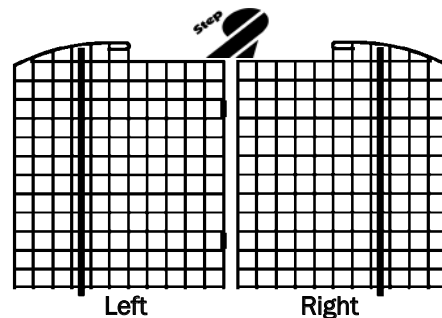

Step 3

Lay the Left Main Panel on top of the Right Main Panel and adjust them to best fit your measurement from Step 1. MidWest recommends that the panels be over lapped by at least 2 "squares," although the barrier will still be stable with one overlapping square.

Step 4

Locate 4 Plastic Clamp Plates, 2 small bolts and 2 small wing nuts. Secure these panels together with the Clamp Plates (H) as shown. Clamp plates should face inward (as shown,) and for assembly convenience, the bolt and wing nut toward the back of the vehicle. Place the clamps so they securely grab 2 wires on each panel.

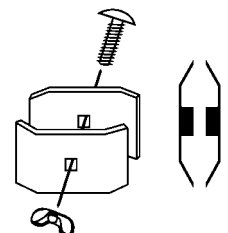
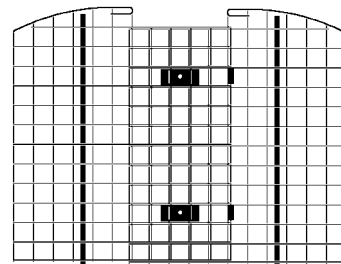
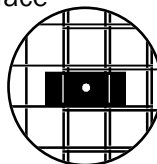



Locate the Small Vinyl Caps (K) . Place the Small Vinyl Tips on the top end of the steel tubing attached to the barrier. Locate the Threaded Rod (E), Large Vinyl Tips (J), the Large Wing Nuts (F) and the Large Lock Washers (G). Place the Lock Washer on the Threaded Rod and start the Wing Nut on the threads. Turn it so that it is about 5" up the rod, then slip the Large Vinyl Tip on the rod behind the nut.



Slide the threaded rods into the tubes. Carefully move the Main Barrier assembly with the rods inserted to your vehicle. Put it in place making sure that the bend at the bottom faces the rear of the vehicle. Turn the Wing Nut on the threads to adjust the barrier height. Tighten the Wing Nuts until the barrier is snug.



Locate the Small Extension Panel (B) and Large Extension Panel (C), the remaining 8 Plastic Clamp Plates, and the remaining 4 Bolts & Small Wing Nuts (I). Depending on your vehicle, the open space outside the Main Barrier assembly will be most effectively filled by the Small or Large Extension Panels. Determine which is best for your application.



With the appropriate Extension Panels, determine which one is the left and right by looking at the border wire along the side. The border wire should face the back of the vehicle.



Position the Extension Panels in the optimal place and use the remaining Clamps, Bolts and Small Wing Nuts to secure them in place as in Step 4.

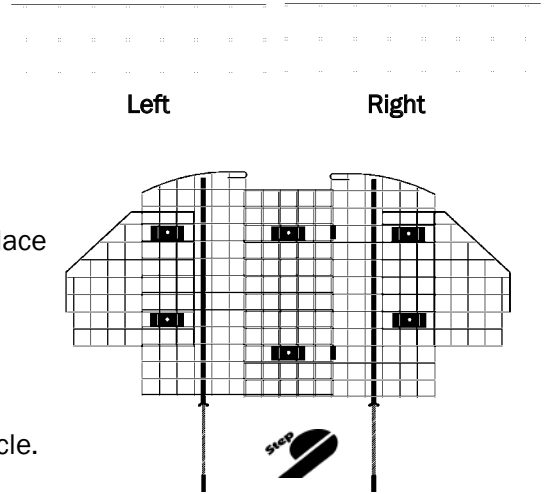

Be sure all wing nuts are tight and barrier is snug in place before use.

You may choose to keep the other set of Extension Panels to use in another vehicle. Or for future use.

LIMITED WARRANTY

- For one (1) year from the date of original purchase, MIDWEST Homes For Pets ("MIDWEST") warrants to the purchaser of this pet barrier that, should it prove defective by reason of improper workmanship and/or material, MIDWEST will repair or replace, at its option, any defective part of the barrier, without charge for the part or for shipping. Replacement parts are warranted for the remainder of the original period.
- THIS WARRANTY DOES NOT COVER** defects caused by any animal, any physical abuse to or misuse of the barrier, negligence, improper installation or overloading, damage to persons, cargo or vehicle, defects caused by improper or illegal vehicle operation or accidents, any damage caused by the original purchaser or any third party, or any defects arising or discovered more than one (1) year from the original retail purchase date.
- STEPS TO OBTAIN WARRANTY SERVICE:**
 - The purchaser must call MIDWEST's HELPLINE, 800-428-8560, to report the alleged defect to a customer service representative or obtain missing parts.
 - The customer service representative will determine if the defect is covered by this warranty, and if it is, will authorize and instruct the purchaser in how to obtain corrective action.
 - MIDWEST may require the purchaser to present the sales receipt or other proof of purchase prior to authorizing any return or replacement. No returns or replacements will be permitted without proper authorization. If a return or replacement is authorized, you may be requested to return the item to MIDWEST or to make the item available for pick-up by MIDWEST.
- ANY EXPRESS WARRANTY NOT PROVIDED IN THIS WARRANTY DOCUMENT, AND ANY REMEDY FOR BREACH OF CONTRACT THAT, BUT FOR THIS PROVISION, MIGHT ARISE BY IMPLICATION OR OPERATION OF LAW, IS HEREBY EXCLUDED AND DISCLAIMED. THE IMPLIED WARRANTIES OF MERCHANTABILITY AND OF FITNESS FOR ANY PARTICULAR PURPOSE ARE EXPRESSLY LIMITED TO A TERM OF ONE (1) YEAR.**

SOME STATES DO NOT ALLOW LIMITATIONS ON HOW LONG AN IMPLIED WARRANTY LASTS, SO THE ABOVE LIMITATIONS MAY NOT APPLY TO YOU.

UNDER NO CIRCUMSTANCES SHALL MIDWEST BE LIABLE TO PURCHASER OR ANY OTHER PERSON OR ANY SPECIAL, INCIDENTAL OR CONSEQUENTIAL DAMAGES, WHETHER ARISING OUT OF BREACH OF WARRANTY, BREACH OF CONTRACT OR OTHERWISE, SOME STATES DO NOT ALLOW THE EXCLUSION OR LIMITATIONS OF INCIDENTAL OR CONSEQUENTIAL DAMAGES, SO THE ABOVE LIMITATIONS OR EXCLUSION MAY NOT APPLY TO YOU.

6. This warranty gives you specific legal rights, and you may also have other rights which vary from state to state.

WARNING:

This product is not intended to be used as a cargo barrier.
Remove collars and tags from pet to prevent possible entanglement.

