

**EFCT-4052**

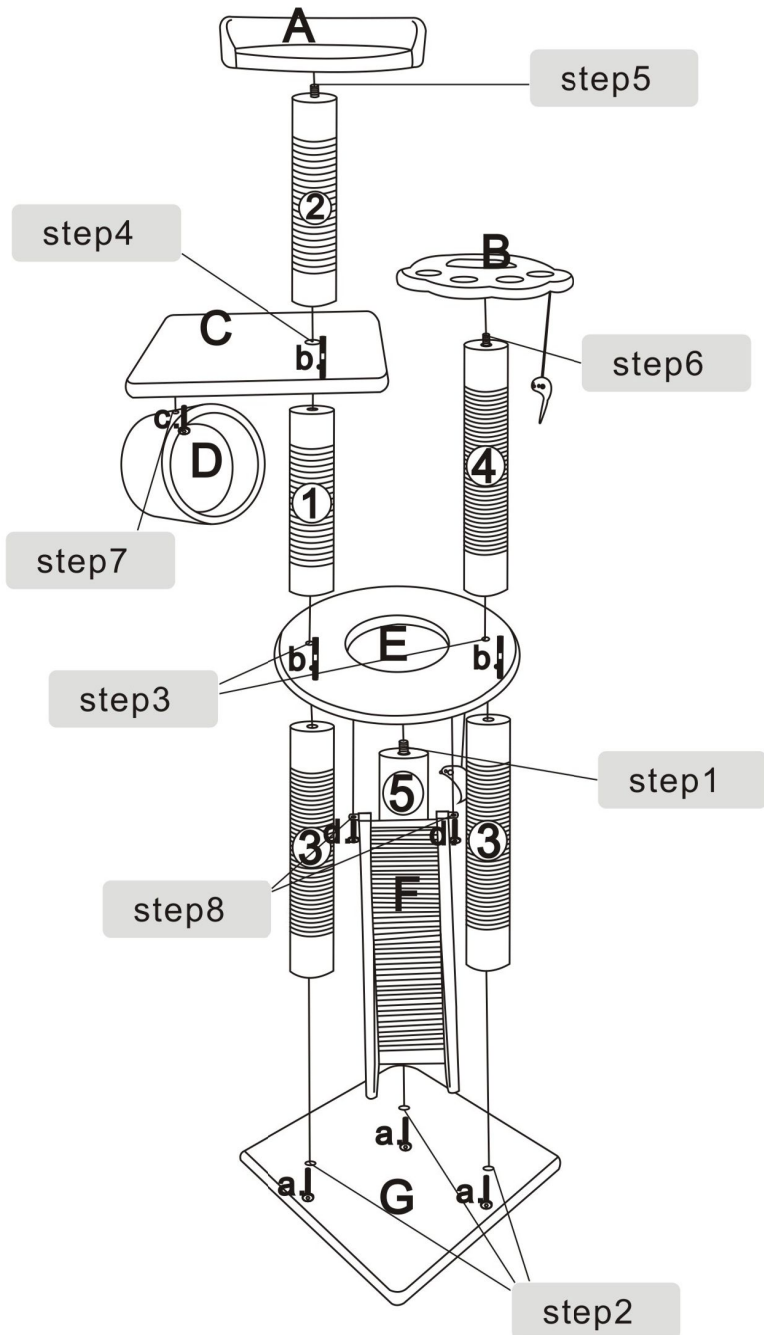

**A.\*1pc**

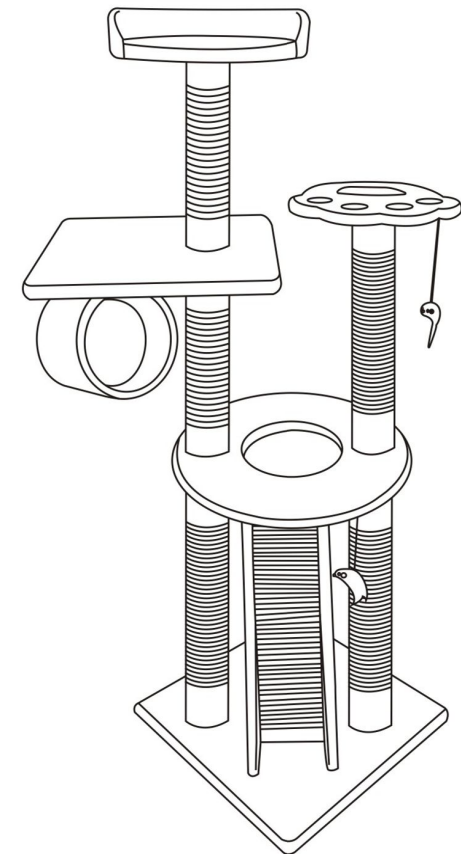

**B.\*1pc**

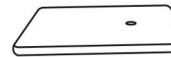

**C.\*1pc**

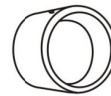

**D.\*1pc**

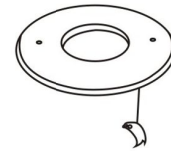

**E.\*1pc**

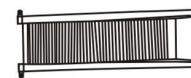

**F.\*1pc**

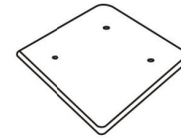

**G.\*1pc**



**13.8"\*1pc**



**15.8"\*1pc**



**16.6"\*2pcs**



**16.6"\*1pc**



**16.6"\*1pc**



**\*1pc**



**a. m0.3"\*1.5"\*3pcs**



**b. m0.3"\*2.6"\*3pcs**



**c. m0.3"\*0.8"\*1pc**



**d. m0.3"\*0.6"\*2pcs**